

Razvoj in preskušanje odbojnikov železniških vozil z elastomernim vzmetnim paketom

The Development and Testing of Rail-Vehicle Buffers Filled with Elastomer Spring Packages

Janko Legat - Nenad Gubeljak - Jožef Predan

V skladu z zahtevami po posodobitvi odbojnih in vlečnih naprav na tirnih vozilih Slovenskih železnic so bili razviti vzmetni paketi z vzmetnimi elementi na podlagi vezave elastomer kovina. Pomemben del raziskav pri preskušanju vzmetnih paketov, po vgradnji v odbojne naprave železniških vozil, je naletno preskušanje vagonov. Z naletom obteženega vozila na mirujoče natovorjeno vozilo se ocenjuje zmožnost odbojne naprave in vzmetnega paketa, da obdrži pojemek mirujočega vozila v dopustnih mejah. V prispevku je predstavljen potek izvajanja preskusov z različnimi hitrostmi naleta in način določevanja koeficienta trka za razviti vzmetni paket. Rezultati opravljenih meritev kažejo, da največji pojemek med trkom obeh vozil tudi pri največjih hitrostih ne preseže dovoljene vrednosti po mednarodnih železniških predpisih. Prav tako so naletni preskusi pokazali, da razviti vzmetni paket poleg dušenja omogoča tudi počasno vračanje povratnega dela.

© 2000 Strojniški vestnik. Vse pravice pridržane.

(Ključne besede: vozila železniška, odbojniki, razvoj, preskušanje)

The decision of the Slovenian Railway Company to modernise the shock absorbing and traction equipment of its existing rolling stock initiated the development of novel spring packages consisting of elastomer-metal-based elements. The crash testing of rail vehicles represents an important part of the testing of spring packages after their installation into buffers. The collision of a loaded rail vehicle with another loaded rail vehicle at a standstill is used to evaluate the capacity of buffers to retain the deceleration of the vehicle at standstill within the permissible limits. The results of tests at different collision velocities and the way of determining the collision coefficient for the developed spring package is described in this paper. The results of measurements show that the maximum deceleration during the collision of two rail vehicles does not exceed the permissible values defined in international railway regulations even at the highest velocities. Crash tests have also revealed that in addition to damping, the developed spring package enables slow reaction work.

© 2000 Journal of Mechanical Engineering. All rights reserved.

(Keywords: rail vehicles, buffers, development, testing)

0 UVOD

Pri Slovenskih železnicah (SŽ) so se v začetku devetdesetih let lotili posodobitve voznih značilnosti sedanjih tirnih vozil. Odbojne naprave, ki neposredno vplivajo na udobje pri ustavljanju vozila, so bile v večini primerov izdelane z vzmetnimi paketi s kovinskimi obročastimi vzmetmi (sl. 1). Pri tovrstnih paketih je karakteristika sestavljena iz položnega in strmega dela. Potek karakteristike je bil v skladu s predpisi Mednarodnega združenja za železnice (UIC) ([1] in [2]), vendar v točki prehoda iz položnega na strmi del ima karakteristika nalom, zaradi česar je pri ustavljanju vozila prihajalo do sunka, ki se je prenašal čez ogrodje vozila na zavorne naprave.

0 INTRODUCTION

In the mid-1990s the Slovenian Railway Company decided to modernise the operating characteristics of its existing rolling stock. Buffers, which directly affect the comfort of passengers during stopping, mostly consisted of spring systems made of metal ring springs (Fig. 1). The characteristic curve of such spring systems is composed of the gradual and the steep part of the slope. The characteristic curve of the existing spring systems was in agreement with the UIC (Union Internationale des Chemins de Fer) regulations ([1] and [2]), but the rupture of the curve at the point of transition from the gradual to the steep part of the slope caused a shock which spread over the framework to the braking system during stopping.

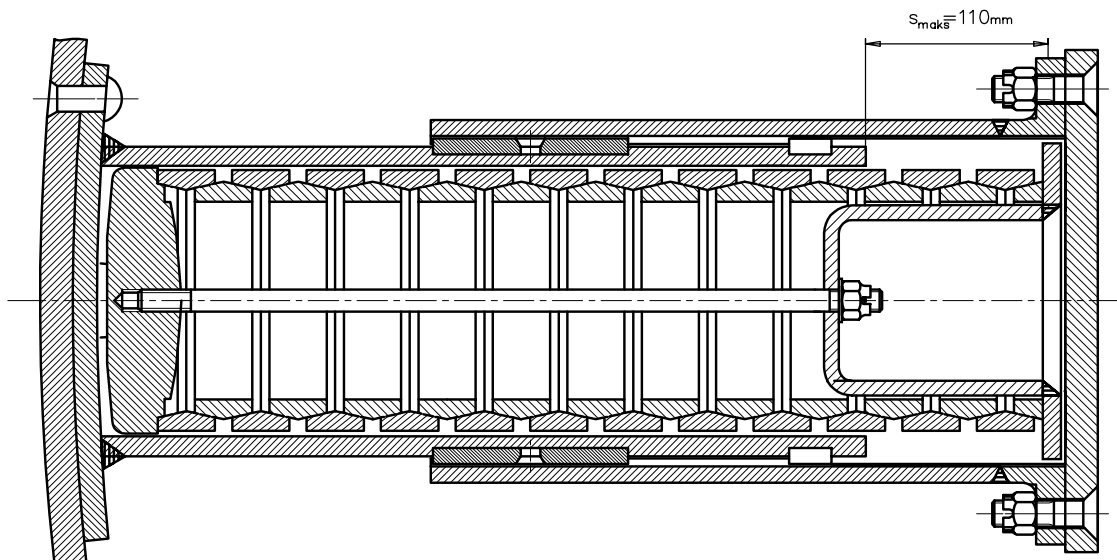

Sl. 1a. *Prerez odbojne naprave z vzmetnimi obroči*
 Fig. 1a. *Section of the buffer with steel ring springs*

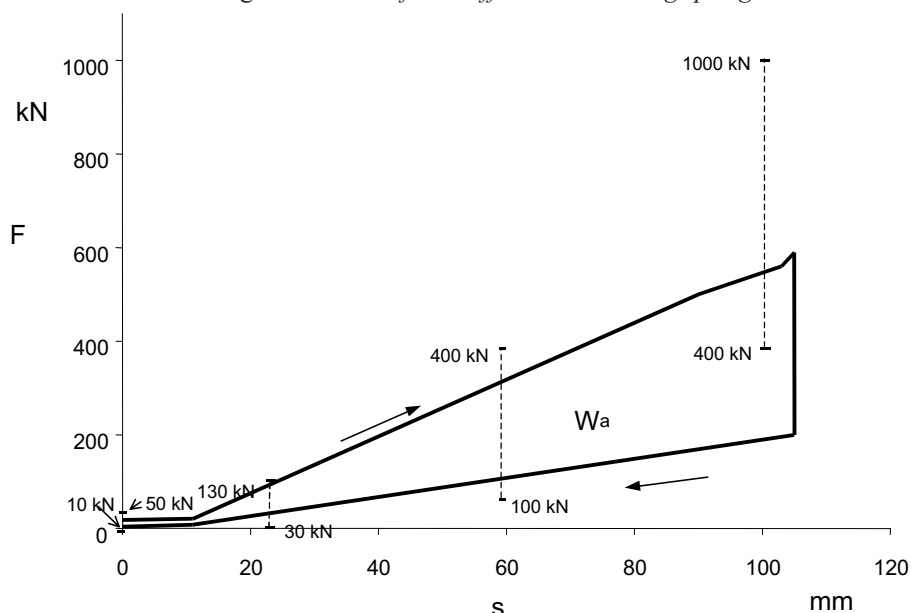

Sl. 1b. *Statična karakteristika vzmetnega paketa z vzmetnimi obroči*
 Fig. 1b. *Static characteristic of the spring system with steel ring springs*

Problem naloma karakteristike pa tudi ovirana oskrba z rezervnimi deli sta bila poglavitna razloga, zaradi katerih so se lotili razvoja elastomernega vzmetnega paketa.

Zaradi nižjih stroškov posodobitve so Slovenske železnice kot naročnik zahtevale, da je treba razviti vzmetni paket vgraditi v sedanje odbojne naprave, s čimer so omejile dolžino in premer vzmetnega paketa. Prav tako mora biti karakteristika vzmetnega paketa v skladu s standardi UIC ([1] in [2]). Oba standarda UIC predpisujeta statične in dinamične pogoje, ki jih mora vzmetni paket izpolniti. Tako je tudi preskušanje vzmetne karakteristike razdeljeno na statično in dinamično.

The problems of the broken characteristic curve and unreliable supply of spare parts were the main reasons to begin the development of elastomer spring packages.

In order to lower the costs of modernisation the Slovenian Railway Company demanded that the developed spring package should be built into the existing buffers, thus limiting the length and the diameter of the spring package. In addition, it was required that the characteristics of the spring package be in accordance with UIC standards ([1] and [2]). These standards define the static and the dynamic conditions that a spring package should fulfil. As a consequence, the testing of the spring characteristics is also divided into

Pri statičnih preskusih poteka stiskanje vzmetnega paketa z nespremenljivo hitrostjo osnega pomika, pri čemer se beleži sprememba sile v odvisnosti od poti. Dinamični preskusi se izvajajo z naletnimi preskusi tirnih vozil z vgrajenimi odbojnimi napravami, pri čemer se merita delo vzmetnega paketa in največji pojemek med trkom.

Ključni pogoj, ki ga mora vgrajen vzmetni paket pri statičnih preskusih izpolniti, je predpisan z višino dela deformacijske energije, ki jo mora odbojnik za določeno pot - deformacijo prevzeti. Od tega pogoja je odvisno, kateri elastomer je treba uporabiti za izdelavo vzmetnega elementa oz. vzmetnega paketa. Za napoved deformacijskega dela je treba definirati reološke parametre, ki se lahko določijo le na podlagi eksperimentalnega obnašanja vzorca, ki je izdelan iz načrtovanega elastomera.

1 DEFINIRANJE REOLOŠKIH PARAMETROV

V primeru visoko - elastičnih materialov [3], material ni opisan s konstantami, temveč s tri-parametrično funkcijo s tremi invariantami v smeri glavnih koordinatnih osi:

$$\beta_r = \beta_r(I_1, I_2, I_3) \quad (1),$$

za invariante I_k v smeri glavnih koordinatnih osi v Cauchy-Greenovem deformacijskem tenzorju [4]. Komponenta Cauchyveve komponente napetosti t_k v smeri glavnih koordinatnih osi je določena z izrazom:

$$t_k = \beta_0 + \beta_1 \cdot \lambda_k^2 + \beta_{-1} \cdot \lambda_k^{-2} \quad k = 1, 2, 3 \quad (2),$$

kjer je λ_k^2 kvadrat defomacije v smeri glavnih koordinatnih osi (vrednosti tenzorja \mathbf{B}); $\Gamma = -1, 0, 1$.

Za nestisljiv material se lahko konstitutivni zakon zapiše:

$$t_k = -p + \beta_1 \cdot \lambda_k^2 + \beta_{-1} \cdot \lambda_k^{-2} \quad k = 1, 2, 3 \quad (3),$$

kjer so p hidrostatična napetost, $\beta_r = \beta_r(I_1, I_2, I_3)$; $\Gamma = -1, 1$ pa dve odzivni funkciji. Beatty and Stalnaker [3] sta pokazala, da omejitev, ki jo je uporabil Bell za različne deformacije v primeru enoosnega obremenjevanja, podana z izrazom:

$$\text{tr} \mathbf{B}^{1/2} = \lambda_1 + \lambda_2 + \lambda_3 = 3 \quad (4),$$

velja tudi za stisljiv in izotropen material. Dejansko se tudi stisljiv material v področju malih deformacij obnaša enako kot nestisljiv. To ustreza trivialnemu primeru, ko so deformacije $\lambda_1 = \lambda_2 = \lambda_3 = 1$.

Povezava med inženirskimi deformacijami ε_k in deformacijo λ_k v smeri glavne koordinatne osi je podana z izrazom:

the static and the dynamic part. The static tests consist of compression loading of the spring system at a constant axial displacement velocity, where the change in force is recorded as a function of the path. The dynamic testing is performed in the form of crash tests of rail vehicles with spring packages installed in buffers, where the work of the spring package and the maximum deceleration during the collision are measured.

The key condition that a spring package must fulfil in static testing is defined by the amount of work (strain energy) the buffer must absorb for a certain path (deformation). The choice of the elastomer to be used in the spring package depends on this condition. To be able to predict the deformation it is necessary to define the rheological parameters. These can only be determined on the basis of the experimental behaviour of the specimen made from the chosen elastomer.

1 DEFINING THE RHEOLOGICAL PARAMETERS

In the case of highly elastic materials [3] the material is not expressed in terms of constants but by a three-parametric function with three invariants in the direction of the principal coordinate axes:

for the invariants I_k in the principal coordinate axes in the Cauchy-Green deformation tensor [4]. The component of Cauchy's stress component (t_k) in the direction of the principal coordinate axis is expressed by:

where λ_k^2 is the square of strain in the direction of principal coordinate axes (the values of tensor β_r); $\Gamma = -1, 0, 1$.

The constitutive law for an incompressible material can be written as:

where p is the hydrostatic stress, while $\beta_r = \beta_r(I_1, I_2, I_3)$; $\Gamma = -1, 1$ are two response functions. Beatty and Stalnaker [3] have shown that Bell's constraint formulation for different deformation in simple tension is given by:

which is also valid for isotropic material. For small deformations, the deforming material may be considered incompressible, where the deformation can be given in trivial deformation state $\lambda_1 = \lambda_2 = \lambda_3 = 1$.

The connection between the engineering strains (ε_k) and the strain (λ_k) in the direction of the principal coordinate axis is given by expression (5):

$$\varepsilon_k = \lambda_k - 1 \quad k = 1, 2, 3 \quad (5).$$

Če obravnavamo nestisljiv izotropen hiperelastičen material kot funkcijo deformacijske energije $W = W(J_1, J_2, J_3)$ na enoto prostornine, lahko zapišemo, da ustreza enačbi (2) v odvisnosti le od J_3 oz. $\beta_r = \beta_r(J_3)$. Posamezni parametri se lahko izrazijo z invariantami I_1, I_2, I_3 :

$$J_1 \equiv I_1 = \text{tr} \mathbf{B} \quad J_2 \equiv \frac{I_2}{I_3} = \text{tr} \mathbf{B}^{-1} \quad J_3 \equiv I_3^{1/2} = \det \mathbf{B} \quad (6a,b,c).$$

Za hiperelastične materiale sta Truesdell in Noll [7] izpeljala naslednje vrednosti za parametre enačbe (2):

$$\beta_0(J_3) = \frac{\partial W}{\partial J_3} \quad (7)$$

$$\beta_1(J_3) = \frac{2}{J_3} \frac{\partial W}{\partial J_1} \quad (8)$$

$$\beta_{-1}(J_3) = \frac{-2}{J_3} \frac{\partial W}{\partial J_2} \quad (9)$$

Z upoštevanjem predpostavljene funkcijske odvisnosti je ugotovljeno [4], da podana razmerja v enačbah (6 a,b,c) veljajo takrat in le takrat, če sta parcialna odvoda v enačbah (8) in (9) enaka nespremenljivi vrednosti, in sicer:

$$\frac{2\partial W}{\partial J_1} = \alpha \quad \frac{2\partial W}{\partial J_2} = \beta \quad (10).$$

Z vpeljavo konstant α, β v izraze ((7) do (9)) za Cauchy-Greenove deformacijske tenzorje dobimo:

$$\beta_0 = W \quad \beta_1 = \frac{\alpha}{J_3} \quad \beta_{-1} = \frac{-\beta}{J_3} \quad (11a,b,c).$$

Za nestisljiv elastomer velja $J_3=1$ in razlika med koeficientoma $\beta_1(1) - \beta_{-1}(1) = \alpha + \beta = \mu_0$ ustreza strižnemu modulu v naravnem stanju materiala [5]. Konstanti α, β sta povezani tudi s konstanto f , ki ima vrednost med $0 < f \leq 1$. To omogoča uvedbo izrazov $\alpha = \mu_0 f$ in $\beta = \mu_0(1-f)$. Z vstavitvijo enačb (11a,b,c) v enačbo (2) dobimo splošni izraz za konstitutivno enačbo hiperelastičnega materiala:

$$\mathbf{T} = W \cdot \mathbf{I} + \mu_0 \cdot f \cdot \mathbf{B} - \mu_0(1-f) \mathbf{B}^{-1} \quad (12).$$

Za izotropen hiperelastičen material v odvisnosti od prirejenih deformacijskih invariant je bilo deformacijsko delo izračunano po Yeohovem modelu [6]:

$$W = C_{10} (I_1 - 3)^2 + C_{20} (I_2 - 3)^2 + C_{30} (I_3 - 3)^2 \quad (13),$$

kjer so C_{10}, C_{20}, C_{30} konstante materiala, ki se določajo iz eksperimentalno izmerjene odvisnosti napetost-deformacija. Yeohov model daje primerne rezultate v

If an incompressible isotropic hyperelastic material is treated as a function of the strain energy $W = W(J_1, J_2, J_3)$ per volume unit we can say that it corresponds to equation (2) by depending only on J_3 or $\beta_r = \beta_r(J_3)$. Individual parameters can be expressed by the invariants I_1, I_2, I_3 :

In their discussion of hyperelastic materials, Truesdell and Noll [7] derived the following values for the parameters of equation (2):

It has been found, by considering the assumed functional relationships, [4], that the relations presented in equations (6 a,b,c) are valid only in the case when the partial derivations in equations (8) and (9) are equal to the constant value:

After introducing the constants α and β into expressions ((7) to (9)) the following is obtained for the Cauchy-Green deformation tensors:

It has been shown that $J_3=1$ is valid for an incompressible elastomer, and that the difference between the coefficients $\beta_1(1) - \beta_{-1}(1) = \alpha + \beta = \mu_0$ corresponds to the shear modulus of the material's natural state [5]. The constants α and β are also related to the constant f whose value is between $0 < f \leq 1$. Thus it is possible to introduce the expressions $\alpha = \mu_0 f$ and $\beta = \mu_0(1-f)$. The general expression for the constitutive equation for a hyperelastic material is obtained by inserting Equations (11a,b,c) into Equation (2):

The deformation work for an isotropic hyperelastic material depending on the modified strain invariants was calculated according to Yeoh's model [6]:

where C_{10}, C_{20}, C_{30} are the material constants determined from the experimentally measured stress-strain relation. Yeoh's model yields acceptable results in

primeru, ko se konstante materiala določajo z enoosnim tlačnim ali nateznim preskusom. Prav tako so parametri Yeohovega modela C_{10} , C_{20} in C_{30} linearno odvisni od prostornine, kar pomeni, da je mogoče na podlagi preskušenelega vzorca ugotoviti celotno delo sestavljenega paketa za enako območje deformacije.

1.1 Eksperimentalna določitev odvisnosti $\sigma-\varepsilon$

Vzorec je izdelal Razvojno tehnološki inštitut podjetja Sava Kranj. Vzorec je bil izdelan iz mešanice elastomera in naravnega kavčuka z dodatki saj in aditivov. Trdota vulkaniziranega vzorca je znašala 68° Sh. Izhodiščna predpostavka je, da je elastomer nestisljiv, kar pomeni, da ohranja nespremenljivo prostornino, le oblika vzorca se spreminja zaradi delovanja zunanje obremenitve. Za tlačni preskus je bil uporabljen standardni valjni vzorec s premerom 29 mm in višino 12 mm (prostornina $V=7926\text{mm}^3$). Med preskusom so bile spremljane spremembe prečne in vzdolžne deformacije v odvisnosti od sile. Statično obremenjevanje s stalno hitrostjo pomika ($v=20\text{ mm/min}$) je bilo zvezno ponavljano do dosega ponavljajoče se karakteristike sila - osni pomik po 5. krogu obremenitve. Karakteristika 1. in 5. kroga je podana na sliki 2. S slike 2 je razvidno, da je razmerje med celotnim delom (površina pod obremenilno krivuljo) in dušenim delom (površina med obremenilno in razobremenilno krivuljo) ugodno ($W_a/W_e=71,5\%$). Zaradi tega je nadaljnja analiza namenjena le določitvi celotnega deformacijskega dela W_e .

Sprememba oblike med tlačnim preskusom je prikazana na sliki 3. Zaradi trenja med podlago in razporeditve napetosti med tlačnim preskusom so

the case when the material constants are obtained by uniaxial compression or tensile tests. The parameters of Yeoh's model C_{10} , C_{20} , C_{30} are linearly volume dependent, which means that it is possible to determine the cumulative work of the assembled spring package from the tested specimen for the same range of deformation.

1.1 Experimental determination of the relation $\sigma-\varepsilon$

The specimen was made in the R&D Institute of the Sava company in Kranj, Slovenia. The material used was an elastomer/rubber mixture containing soot and some additives. The hardness of the vulcanised specimen is 68°Sh. The basic assumption is that the elastomer is incompressible, which means that its volume remains constant, only the shape of the specimen changes due to the action of external loading. A standard cylindrical specimen with a diameter of 29 mm, a height of 12 mm and a volume (V) of 7926mm^3 was used in the compression-loading test. During the test the radial and the axial strains were recorded as the force was varied. Static loading at a constant displacement velocity ($v=20\text{ mm/min}$) was continuously repeated until the reproducibility of the force-axial displacement characteristic was reached during the fifth loading cycle. The characteristics of the first and the fifth cycles are shown in Fig. 2. It is evident from Fig. 2 that the ratio of the cumulative work (the surface under the loading curve) to damping work (the surface between the loading and the decompression curve) is favourable ($W_a/W_e=71,5\%$). Further analysis will therefore be focussed only on the determination of the cumulative work of deformation W_e .

The change in shape during the compression test is shown in Fig. 3. Due to the friction between the specimen surface and the steel base sur-

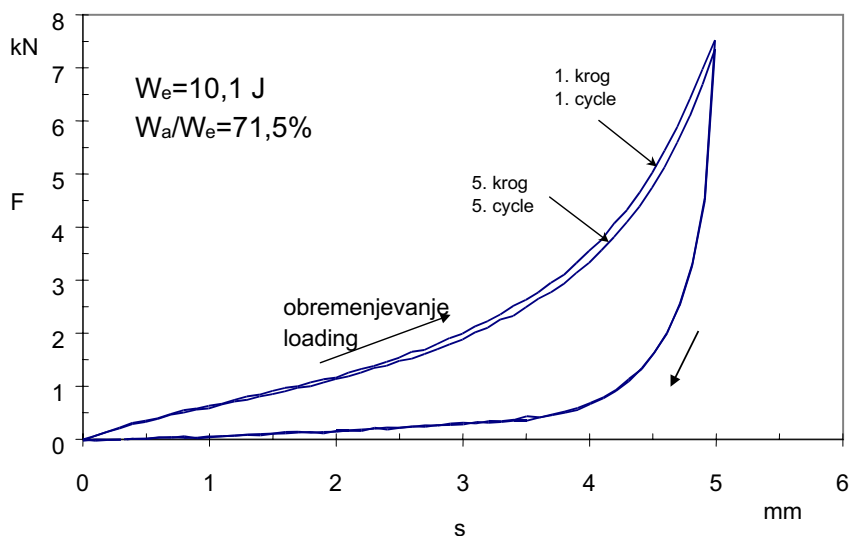

Sl. 2. Statično (tlačno) obremenjevanje valjnega vzorca
Fig. 2. Static (compression) loading of cylindrical specimen

najmanjše deformacije izmerjene v stičnem delu med vzorcem in podlago (premer r_1), medtem ko so največje deformacije dosežene v srednjem delu vzorca (premer r_2).

Na podlagi spremembe oblike in višine obremenitve so določene odvisnosti med deformacijami $\varepsilon_1, \varepsilon_2, \varepsilon_3$ in tlačno napetostjo σ_z , kakor je prikazano na sliki 4.

face, and also due to the compressive stress distribution, the smallest strains were measured on the contact surface between the specimen and the base (diameter r_1), and the largest strains in the middle part of the specimen (diameter r_2).

The relations between the strains $\varepsilon_1, \varepsilon_2, \varepsilon_3$ and the compressive stress σ_z were determined from the change in shape and the loading, as shown in Fig. 4.

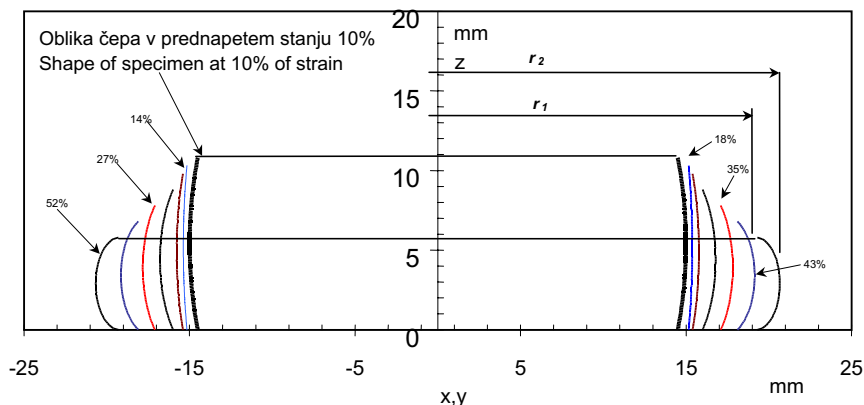

Sl. 3. Sprememba oblike vzorca med tlačnim preskusom
Fig. 3. Changes in specimen shape during compression loading

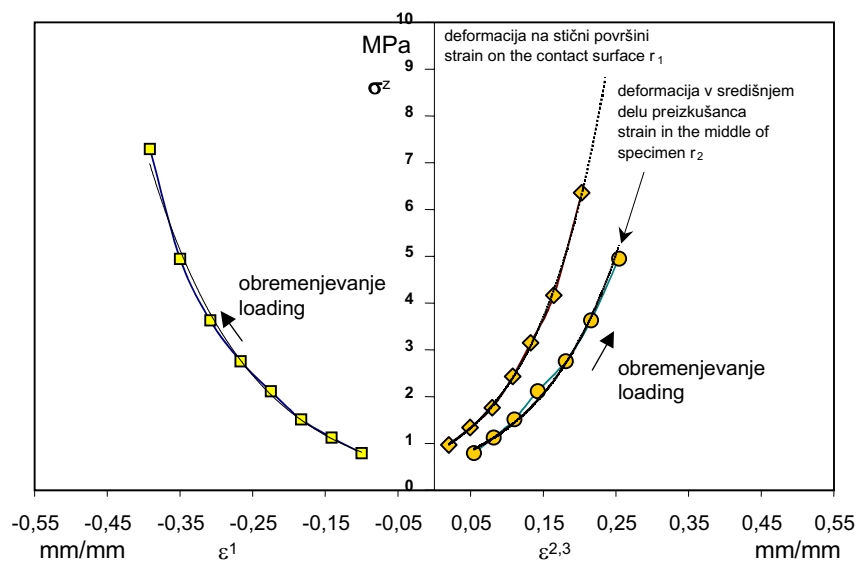

Sl. 4. Sprememba deformacij $\varepsilon_1, \varepsilon_2, \varepsilon_3$ v smeri glavnih osi pod vplivom tlačne napetosti σ_z
Fig. 4. Relationship between principal strains $\varepsilon_1, \varepsilon_2, \varepsilon_3$ and compressive stress σ_z

Deformacijske invariante I_1, I_2 in I_3 , ki so normirane s prostornino vzorca, so določene na podlagi deformacij v posameznih smereh $\varepsilon_1, \varepsilon_2, \varepsilon_3$ po enačbah (5) do (7) po posameznih točkah. Iz znanih vrednosti za delo $W_{e,i}$ v posamezni točki deformacije in pripadajočih vrednosti deformacijskih invariant in rešitve sistema linearnih enačb so določene vrednosti koeficientov $C_{10} = -4,9 \cdot 10^{-4}$, $C_{20} = 3,53 \cdot 10^{-4}$, $C_{30} = 1,72 \cdot 10^{-4}$ v Yeohovem modelu v območju od 10 do 43 % deformacije na enoto prostornine.

Z izračunanimi koeficienti Yeohovega modela je bila opravljena primerjava med

The strain invariants I_1, I_2 and I_3 that are normed by the volume of the specimen are determined on the basis of principal strains $\varepsilon_1, \varepsilon_2$ and ε_3 according to equations (5) to (7) in individual points. On the basis of the known values for work $W_{e,i}$ in individual strain points and the corresponding values of strain invariants, and by solving the system of linear equations, we can determine the values of the coefficients $C_{10} = -4,9 \cdot 10^{-4}$, $C_{20} = 3,53 \cdot 10^{-4}$, $C_{30} = 1,72 \cdot 10^{-4}$ in Yeoh's model in the range of 10 to 43% of strain per volume unit.

The calculated coefficients of Yeoh's model were used to compare the experimentally determined

deformacijsko energijo, določeno s preskusom, in z modelom izračunano deformacijsko energijo v odvisnosti od osne deformacije ε_1 . Eksperimentalne vrednosti za deformacijsko energijo $W_{\text{eksp},i}$ so izračunane kot integral pod obremenilno krivuljo $F-z$ (sl. 2), za posamezno stopnjo deformacije $\varepsilon_1 = z/h_o$ (kjer je z pomik v smeri osi in h_o začetna višina vzorca). Z upoštevanjem pripadajočih vrednosti invariant I_1 , I_2 in I_3 pri pripadajočih deformacijah $\varepsilon_1, \varepsilon_2, \varepsilon_3$ v smeri glavnih osi po enačbi (13) so izračunane vrednosti deformacijske energije po modelu $W_{\text{mod},i}$. Primerjava med obema deformacijskima energijama kaže dobro ujemanje med eksperimentalno izmerjeno in z modelom izračunano vrednostjo.

Tako je na podlagi konstant modela v enačbi (13) mogoče izračunati deformacijsko energijo istega elastomera v razpoložljivi prostornini odbojne naprave. Ker elastomer pri največjem stisku ne sme priti v stik z ogrodjem odbojnika, mora biti deformiranje elastomera vodeno v prečni in vzdolžni smeri. To je doseženo z vulkanizacijo elastomera na jekleno ploščo, s čimer je dobljen vzmetni element, ki je prikazan na sliki 6. Za zagotovitev enakomerne radialne deformacije vseh elementov v paketu so med vzmetne elemente vstavljene drsne plošče, ki so enake jeklenim ploščam za vzmetne elemente. Sestavljen vzmetni paket [6] iz vzmetnih elementov in drsnih plošč je prikazan na sliki 7. Izvrtina 20mm na drsnih ploščah in vzmetnih elementih je prirejena za vodilni drog, ki omogoča nastavitev sile prednapetja in dolžine vzmetnega paketa pred vgradnjo v odbojno napravo, kakor je prikazano na sliki 8a. Za optimalno izkoriščenost razpoložljive prostornine v odbojniku, kar pomeni polno popolnitev prostora z elastomerom pri stisnjem paketu, smo obliko bočnice določali tako, da smo opazovali potek drsenja bočnice elastomera po drsni plošči med razbremenjevanjem.

strain energy with the strain energy calculated by the model depending on the principal strain ε_1 . The experimental values for the strain energy $W_{\text{eksp},i}$ were calculated as an integral under the load curve $F-z$ (Fig. 2) for individual strain rates $\varepsilon_1 = z/h_o$, where z stands for the displacement in the direction of the axis and h_o represents the initial height of the specimen. The strain energy values calculated according to the model $W_{\text{mod},i}$ were obtained by taking into account the corresponding values for the invariants I_1 , I_2 and I_3 for the corresponding principal strains $\varepsilon_1, \varepsilon_2, \varepsilon_3$ according to equation (13). The comparison of both strain energies shows a good agreement between the experimentally measured and the calculated values, as shown in Fig. 5.

On the basis of the model constants in equation (13), it is possible to calculate the strain energy of the same elastomer in the available buffer volume. As the elastomer should never come in contact with the body of the buffer, not even at maximum compression, the deforming of the buffer must be guided in the radial and axial directions. This is achieved by vulcanising the elastomer on a steel plate, which produces the element shown in Fig. 6. Sliding plates, equal to those used for spring elements, were installed between the individual spring elements of the whole package in order to assure equal radial deformation of all the elements. The spring elements and sliding plates assembled in the spring package [6] are shown in Fig. 7. A borehole (20 mm) in the sliding plates and in the spring elements is made for the guiding rod which serves to set the prestressing force and the length of the spring package before installation into the buffer body, as shown in Fig. 8a. To achieve optimal use (efficiency) of the available buffer volume, i.e. full filling of the space with the elastomer when the spring package is contracted, the shape of the edge had to be defined, which was achieved by observing the sliding of the elastomer's edge over the sliding

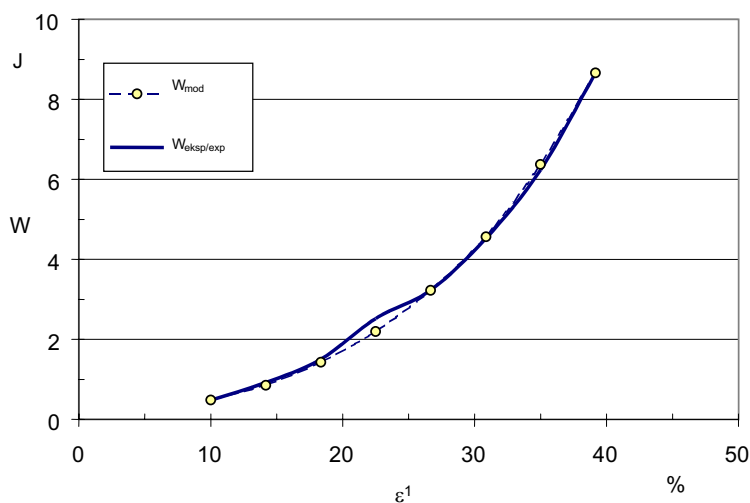

Sl. 5. Primerjava med eksperimentalno izmerjeno deformacijsko energijo in deformacijsko energijo, izračunano po modelu

Fig. 5. Comparison between the experimentally determined and modelled strain energy vs. principal strain ε_1

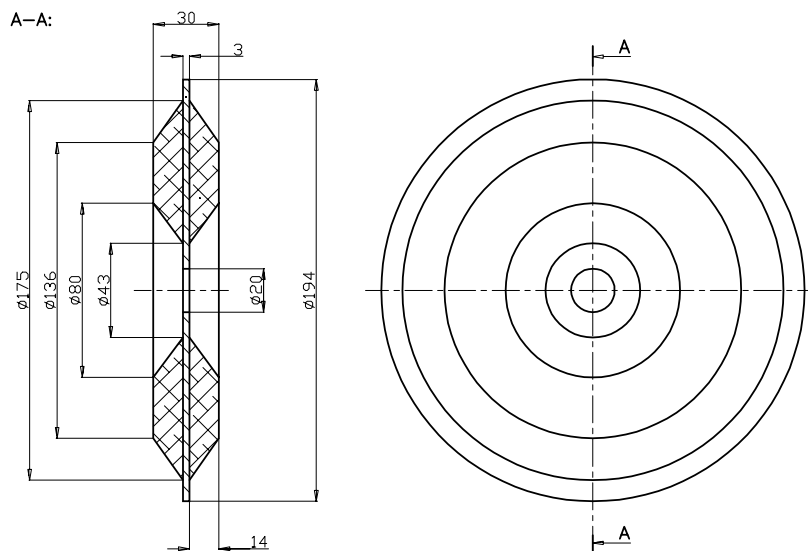

Sl. 6. Vzmetni element
Fig. 6. Spring element

Vpeljan vzmetni paket ima statično karakteristiko v celoti gladko zvezno ter hkrati izpolnjuje pogoje v skladu s standardi UIC ([1] in [2]), kakor je prikazano na sliki 8b. To pomeni, da mora obremenitvena krivulja potekati med predpisanimi najmanjšima in največjima vrednostima (npr. pri 60 mm pomika mora biti sila med 100 in 400 kN) ter mora biti celotno delo vzmetnega paketa večje od 20 kJ pri razmerju $W_a/W_c > 50\%$.

Za izbrano prostornino elastomera ($V=25,135\text{ l}$) v vzmetnem paketu iz 14 vzmetnih elementov je mogoče z upoštevanjem izračunanih konstant Yeohovega modela oceniti deformacijsko delo - energijo celotnega vzmetnega paketa. Primerjava med napovedanim in eksperimentalno izmerjenim delom celotnega paketa je podana na sliki 9. Izrazito odstopanje v območju med 20 do 35% deformacije je posledica omejitve ene proste površine pri vzmetnem elementu, v nasprotju od vzorca, pri katerem sta bili obe površini prosti. Prav tako je razlog za odstopanje med napovedanim in s preskusom izmerjenim delom lahko v razliki med sestavo elastomera pri vzorcu in elastomerom, ki je uporabljen za izdelavo vzmetnega paketa. Čeprav so odstopanja v sestavi elastomera v dopustnih mejah, se lahko lastnosti med serijo razlikujejo tudi do 10% [7]. Kakorkoli že, na podlagi slike 9 lahko pričakujemo, da bo vzmetni paket pri tlačni deformaciji med 35 do 38% (kar ustreza pomiku vzmetnega paketa med 90 do 100 mm) presejel 20 kJ in s tem izpolnil pogoj po standardih UIC ([1] in [2]). Namen vzmetnega paketa je, da kinetično energijo trka pri tlačnem obremenjevanju porabi za povratno in dušeno delo. Delo pri stiskanju paketa je sestavljeno iz dela deformacije elastomera, pri katerem prihaja do razmreženja elastomera [8] ter dela kotaljenja in drsenja proste površine

plate during restitution. The static characteristic of the developed spring package is smoothly continuous and fulfils the requirements of the UIC standards ([1] and [2]) (Fig. 8b). This means that the loading curve must run between the prescribed minimum and maximum values (e.g. the force must be between 100 and 400 kN at a displacement of 60 mm) and that the cumulative work of the spring package must be higher than 20 kJ at the ratio $W_a/W_c > 50\%$.

It is possible to evaluate the cumulative work-strain energy of the whole spring package consisting of 14 spring elements for the planned elastomer volume ($V=25,135\text{ l}$) by taking into account the calculated constants of Yeoh's model. The comparison between the anticipated and the experimentally measured work of the whole package is given in Fig. 9. A substantial deviation in the range between 25 to 35% of strain is a consequence of one missing free surface of the spring element in contrast to the specimen where both surfaces were free. Another reason for the difference between the predicted and the measured work may result from the difference between the composition of the elastomer specimen and the elastomer used for the spring package. Although the deviations in the composition of elastomers are within the permissible limits, the properties of the series may vary by up to 10% [7]. In any case, it is evident from Fig. 9 that we can reasonably expect the spring package to exceed 20 kJ at the pressure strain of 35 to 38%, which corresponds to the displacement of the spring package from 90 to 100 mm, and thus to fulfil the condition stated in the UIC standards ([1] and [2]). The purpose of the spring package is to use the kinetic energy of collision during compression loading for the work of restitution and damping. The work during package compression consists of the elastomer deformation work, where de-crosslinking of the elastomer takes place [8], and the work of rolling and sliding of the elastomer's free

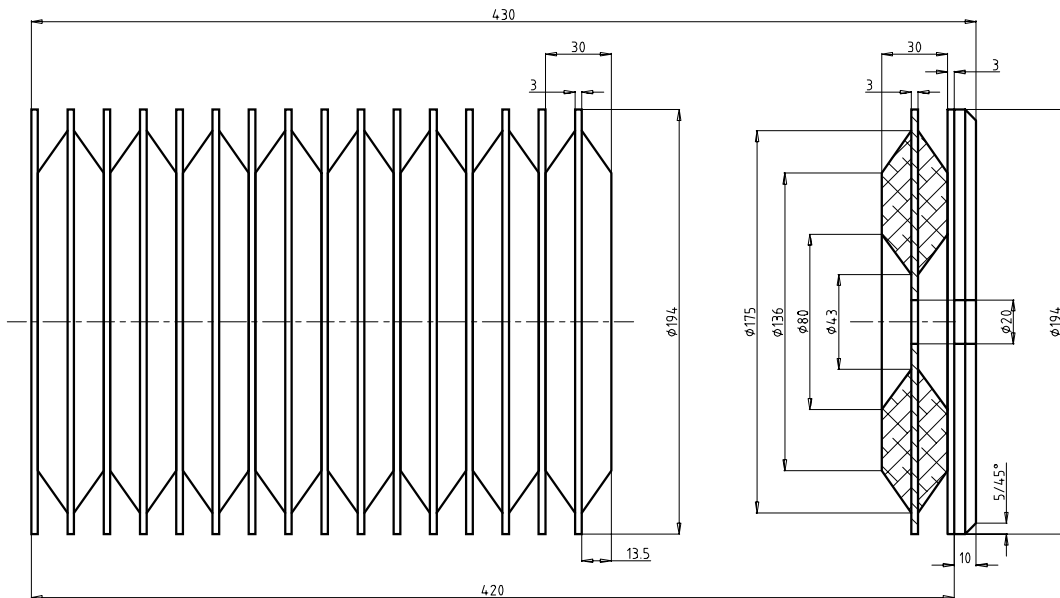

Sl. 7. Sestavljen vzmetni paket
Fig. 7. Assembled spring package

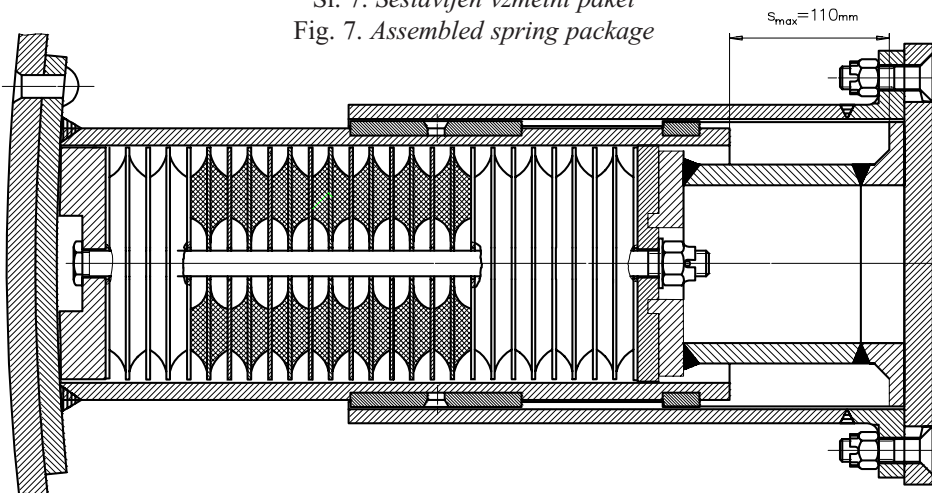

Sl. 8a. Prerez odbojne naprave z elastomernim vzmetnim paketom
Fig. 8.a. Section of the buffer with the assembled elastomer spring package

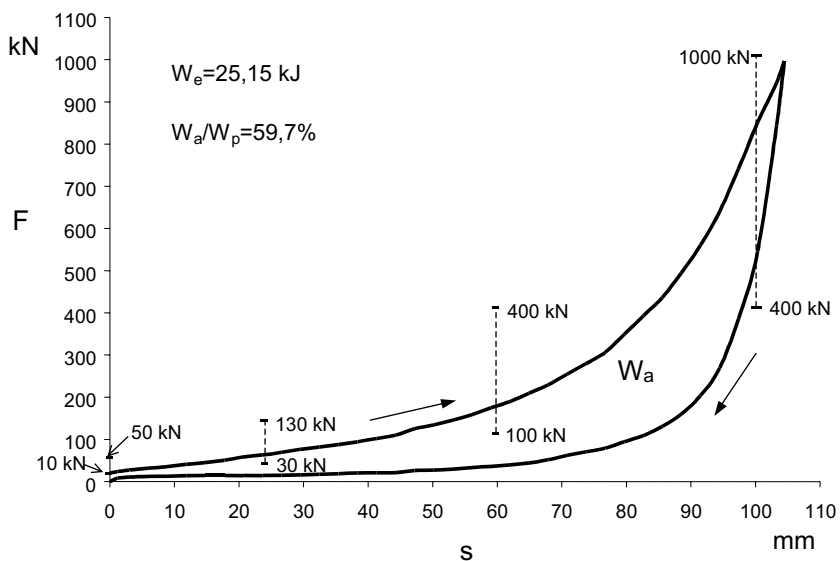

Sl. 8b. Statična karakteristika vzmetnega paketa z elastomerom
Fig. 8.b. Static characteristic of the spring package with elastomer

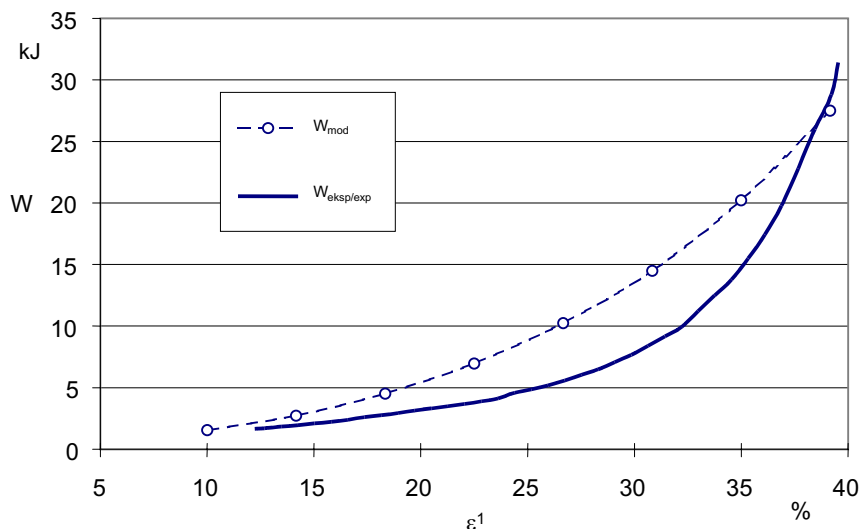

Sl. 9. Primerjava med napovedano in eksperimentalno izmerjeno deformacijsko energijo vzmetnega paketa
Fig. 9. Comparison between the predicted and the measured strain energy of the spring package

elastomera po drsni plošči. Mešanico za elastomer, kakor tudi tehnologijo vezave elastomera na kovino, je razvil Razvojno tehnološki inštitut (RTI) Sava Kranj [7].

surface over the sliding plate. The elastomer mixture and the technology of binding the elastomer on the metal were developed at the R&D Institute of the Sava company in Kranj, Slovenia [7].

2 NALETNO PRESKUŠANJE ŽELEZNIŠKIH ODBOJNIKOV

2 CRASH TESTING OF BUFFERS

V nasprotju s statičnimi preskusi pri dinamičnih naletnih preskusih ni predpisan potek obremenitvene krivulje, temveč le višina celotnega in dušenega dela ter največje dopustne vrednosti za pospeške, pri čemer sila v odbojni napravi ne sme preseči 1000 kN.

In dynamic crash tests, unlike static tests, the loading curve is not prescribed, just the magnitude of the cumulative and damping work and the maximum permissible acceleration values. In addition, the force in the buffer must not exceed 1000 kN.

Predpisi UIC ([1] in [2]) določajo tudi pogoje, pod katerimi so meritve odločujoče. Tako sta bila oba vagona (m_1 in m_2) postavljena na ravnih in ne visečih tirih z najmanjšimi napakami na tirnicah. Zaradi varnosti je bilo načrtovano, da bo preskuševalni ravni del proge dolg 1000 m. Tako je bilo mogoče predpostaviti, da se bo trk vagonov opravil v smeri normale, ki povezuje težišča obeh vagonov. Dinamiko naletnega preskusa je mogoče teoretično opisati kot trk dveh teles [9]. Vagon mase m_1 se giblje s hitrostjo v_1 proti mirujočemu vagonu ($v_2 = 0$). V času trka so vagoni v kratkem časovnem stiku, pri čemer ločimo dva časa: čas stiskanja in čas raztezanja. V času stiskanja vzmetnih paketov se zaradi sil na dotikalnih površinah (odbojnikih) vzmetni paketi vse bolj deformirajo. V tem času, ki traja od nekega začetnega časa t_0 do t_1 , se povečuje sila F v odbojniku od sile prednapetja F_p do največje sile F_{maks} (sl. 10).

The UIC regulations ([1] and [2]) also define the conditions under which measurements are recognised to be competent. Thus two rail vehicles (m_1 and m_2) were placed on a straight horizontal track with minimum rail defects. For the sake of safety the testing track was 1000 m long. In this way we could expect the vehicles to collide in the direction of the normal that connects the centres of gravity of both vehicles. The dynamics of the crash test can be theoretically described as a collision of two bodies [9]. The vehicle with mass m_1 moves at velocity v_1 towards the vehicle at rest ($v_2 = 0$). During the collision the vehicles are in contact for a short time interval that consists of the contraction and the restitution time. During the contraction time the deformation of spring packages keeps increasing due to the forces acting on the contact surfaces (buffers). During this time interval, which lasts from the initial time (t_0) to the time t_1 , the force F in the buffer increases from the prestressing force F_p to the maximum force F_{max} (Fig. 10).

V času t_1 so vzmetni paketi najbolj stisnjeni. Čas raztezanja traja od časa t_1 do t_2 , ko vzmetni paket opravlja povratni gib. V času t_1 se oba vagona gibljeta z enako hitrostjo c_N v smeri normale.

Spring packages are maximally contracted at the time t_1 . The restitution time lasts from t_1 to t_2 when the spring package performs the recovery movement. In the time t_1 both vehicles move in the direction of the normal at the same velocity c_N .

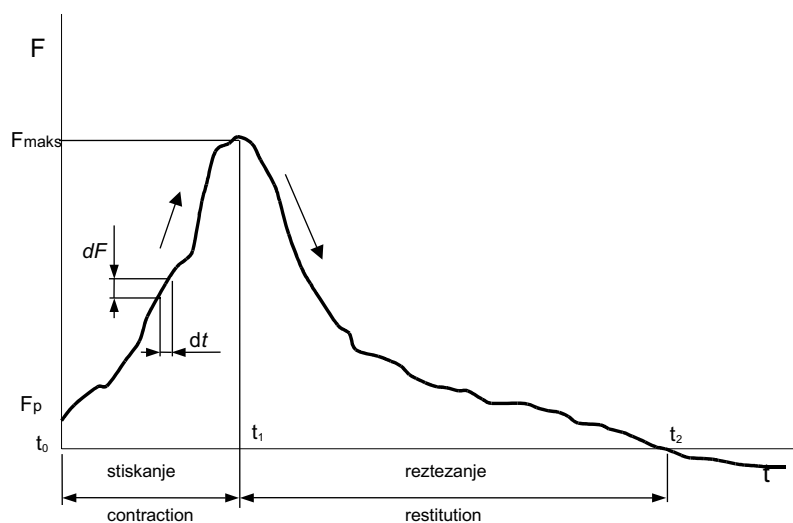

Sl. 10. Sprememba sile F na vzmetnem paketu v času stiskanja in raztezanja
 Fig. 10. Example of measured force F in the spring package during compression and decompression

Parametri naletnega preskusa, to so pot, sila, hitrost in delo, so časovno odvisne spremenljivke, zaradi česar se podaja izraz za zakon o gibalni količini le v posameznem trenutku naleta. Komponenta zakona o gibalni količini v smeri normale je za oba vagona med stiskanjem (od t_0 do t_1) podana z enačbami:

$$m_1 \cdot \frac{dc_N}{dt} + m_1 \cdot \frac{dv_1}{dt} = F(t) \quad (14)$$

$$m_2 \cdot \frac{dc_N}{dt} - m_2 \cdot \frac{dv_2}{dt} = -F(t) \quad (15).$$

Podobno velja za čas raztezanja (t_1 do t_2):

$$m_1 \cdot \frac{dc_N}{dt} - m_1 \cdot \frac{dv_1}{dt} = F(t) \quad (16)$$

$$-m_2 \cdot \frac{dc_N}{dt} - m_2 \cdot \frac{dv_2}{dt} = -F(t) \quad (17).$$

Enačbe od (14) do (17) prikazujejo spremembo sile $F(t)$ na obeh vozilih zaradi spremembe hitrosti med trkom.

Med naletom in trkom se nenadzorovano porabi del kinetične energije naleta zaradi trenja v ležajih osnih dvojic ter trenja med kolesi in tiri, kakor tudi zaradi nihanj amortizerjev in ogrodja vozila. Zaradi tega je mogoče reološke lastnosti odbojnika določiti šele z neposredno meritvijo spremembe sile in pomika v odvisnosti od časa na samem odbojniku. Meritev na odbojniku se izvaja tako, da je sonda za silo postavljena med odbojnikom in ogrođjem vozila, medtem ko sonda pomika meri pomik med odbojno ploščo in pritrujenim ogrođjem odbojnika, kar je prikazano na sliki 11. S tem postopkom je mogoče neposredno opredeliti energijo, ki je potrebna za določen povos odbojnika, ter z meritvijo povratnega dela določiti delež izgube kinetične

The parameters of the crash test (path, force, velocity and work) are time-dependent variables, so the expression for the momentum law is given for individual instants of the impact only. The component of the momentum law in the direction of the normal during the contraction time is expressed for both vehicles by the equations:

A similar situation applies to the restitution time (t_1 to t_2):

Equations (14) to (17) show the change in force $F(t)$ due to velocity changes during the collision for both vehicles.

During the collision a part of the kinetic energy is spent uncontrolled, which is ascribed to the friction in bearings and the friction between wheels and rails, and also to the oscillations of the vehicle body and shock absorbers. This is the reason why the rheological properties of the buffer can be determined only on the buffer by direct measurements of force and displacement as a function of time. For the measurements on the buffer the gauge for force measurements is placed between the buffer and the vehicle body, while the displacement gauge lies between the movable buffer plate and the fixed buffer body, as shown in Fig. 11. In this way it is possible to directly define the energy needed for a certain flexure (deflection) of the buffer. The kinetic energy loss is obtained with the help of reaction work measurements as the difference between the cumulative work and the restitution work.

energije kot razliko med celotnim in povratnim delom. Izgubljena kinetična energija pri stiskanju odbojnika je porabljena za deformacijo in razmreženje elastomera ter toplotno energijo trenja med ploščami in v samem elastomeru.

Potrebno delo (W_e) za stiskanje vzmetnega paketa in s tem odbojnika se izračunava z numerično integracijo krivulje sila - pomik. Delo dušenja W_a se lahko določi kot razlika med celotnim in povratnim delom, oziroma se lahko določa enako kakor W_e , le da se upošteva numerična integracija v razponu od t_1 do t_2 . Odbojnik odda povratno delo W_p v obliki kinetične energije, ki je izražena kot sprememba relativne hitrosti vozila po trku:

$$u_2 - u_1 = \Delta u = \sqrt{\frac{2W_p}{m_1}} \quad (18).$$

Razmerje med relativno hitrostjo po trku $\Delta u = u_2 - u_1$ in relativno naletno hitrostjo $\Delta v = v_1 - v_2$ pomeni koeficient trka k :

$$k = \frac{\Delta u}{\Delta v} = \frac{u_2 - u_1}{v_1 - v_2} \quad (19).$$

Vrednost koeficienta trka je za popolnoma plastičen trk $k=0$, oziroma za popolnoma elastičen trk $k=1$.

Naletno preskušanje železniških vagonov je izvajal Zavod za raziskavo materialov in konstrukcij - ZRMK pod nadzorom nosilca razvojne naloge - Fakultete za strojništvo Maribor, na delu proge med Ptujem in Moškanjci.

Obe železniški vozili sta bili natovorjeni z bremenom nominalne mase 40 t ($m_1=40230$ kg, $m_2=40125$ kg) in opremljeni z razvitimi vzmetnimi paketi. Hitrost gibajočega se vagona (v_1) pred trkom je bila merjena z dvema fotocelicama na referenčni razdalji. Sile, pomiki in pospeški so se merili z ustreznimi zaznavali. Sila je bila merjena s sondo Hotinger Baldwin Messtechnik-HBM 200C6A, z merilnim območjem do 2 MN in z natančnostjo $\pm 0,5\%$. Pomik je bil merjen s sondo WA 100 z merilnim območjem do 100 mm in natančnostjo $\pm 1\%$. Ojačani signali (ojačevalnik HBM KWS 6A-5) iz zaznaval so se prek analogno-digitalnega pretvornika DAP 2400/6 zbirali z računalnikom. Povezovalna shema je prikazana na sliki 11.

Posnete karakteristike odvisnosti sile in pomika od časa na enem odbojniku med naletom so za posamezne hitrosti naleta prikazane na slikah 12 do 15.

Za vse posnete karakteristike na slikah 12 do 15 je značilno, da je čas stiskanja (čas doseganja najvišje sile med trkom) bistveno krajši od dolžine trajanja raztezanja povratnega giba, in sicer praviloma tako, da se z večanjem naletne hitrosti čas stiskanja znižuje ob hkrati daljšem trajanju celotnega trka, kar

The kinetic energy lost during buffer compression is spent for the deformation and de-crosslinking of the elastomer, and also for the heat energy of friction between the plates and in the elastomer.

The work (W_e) needed for the contraction of the spring package and the buffer is calculated by the numerical integration of the force-displacement diagram. The work needed for damping (W_a) is determined as the difference between the cumulative work and the restitution work, or may be defined in the same way as W_e , only that the numerical integration is considered in the interval from t_1 to t_2 . The buffer gives out the restitution work (W_p) in the form of kinetic energy, which is expressed as a change in the relative velocity of the rail vehicle after collision:

The ratio of the relative velocity after collision $\Delta u = u_2 - u_1$ to the relative initial velocity $\Delta v = v_1 - v_2$ is presented by the coefficient of collision (k):

The value of the collision coefficient for a plastic collision is $k=0$, and $k=1$ for an elastic collision.

Crash testing of rail vehicles was performed by the ZRMK (Materials and Structure Testing Institute) under the supervision of the chief investigator of the Faculty of Mechanical Engineering in Maribor on the railway line between the towns Ptuj and Moškanjci.

Both railway vehicles, equipped with the developed spring packages, were loaded by a cargo of nominal weight 40 t ($m_1=40230$ kg, $m_2=40125$ kg). The speed of the moving vehicle (v_1) before collision was measured by two photocells at a reference distance. Forces, displacements and accelerations were measured by gauges. The force was measured by a Hotinger Baldwin Messtechnik 200C6A-type gauge, with a measuring range of up to 2MN and an accuracy of $\pm 0.5\%$. The displacement was measured by a WA 100-type gauge, with a measuring range up to 100 mm and an accuracy of $\pm 1\%$. Data acquisition of the amplified signals from the gauges was performed via an A/D converter (Fig. 11).

The recorded characteristics of the time dependency of force and displacement on one buffer during the collision are given in Figs. 12 to 15 for individual velocities.

It is typical of all the recorded characteristics shown in Figs. 12 to 15 that the contraction time (the time to reach the highest force during the collision) is substantially shorter than the time of restitution. As a rule, the contraction time decreases with increasing initial velocity, while the total collision time

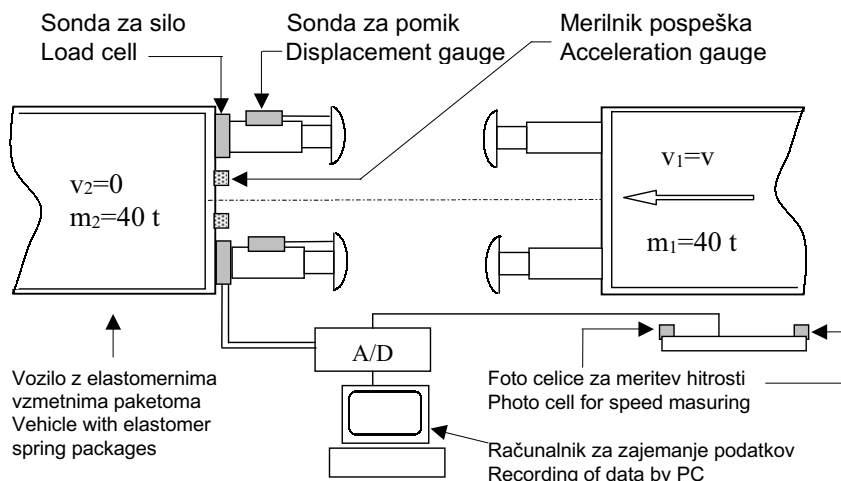

Sl. 11. Shematski prikaz razporeditve merilne opreme med izvajanjem naletnega preskusa
 Fig. 11. Schematic presentation of the measuring equipment during the crash test

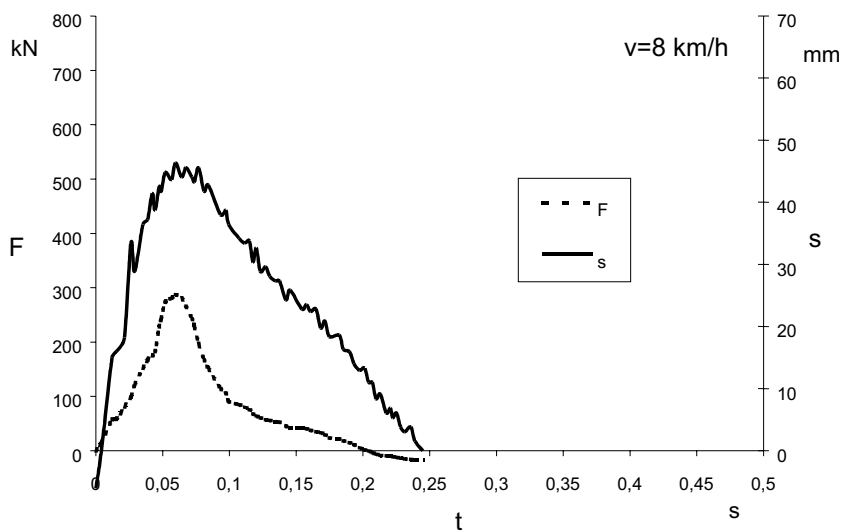

Sl. 12. Posneta karakteristika pri hitrosti naleta $v = 8 \text{ km/h}$
 Fig. 12. The recorded characteristic for initial velocity $v=8 \text{ km/h}$

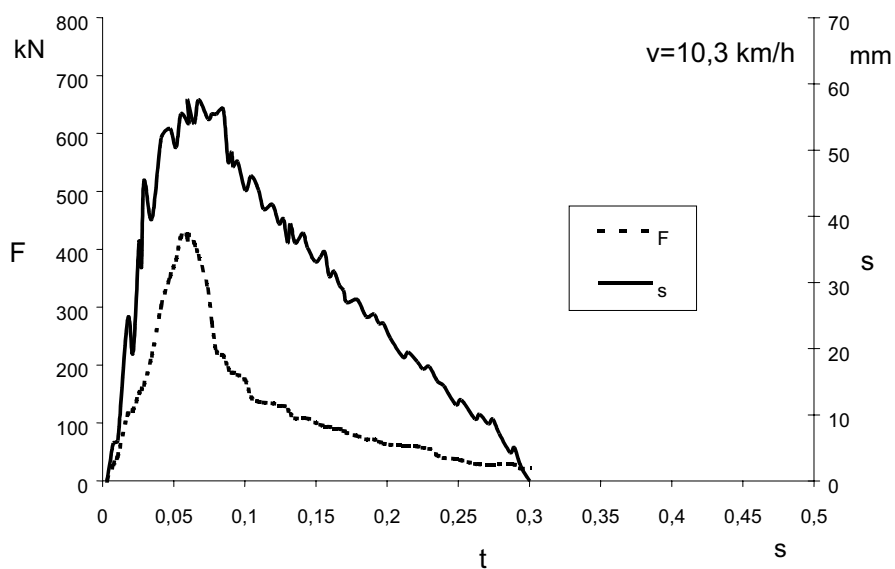

Sl. 13. Posneta karakteristika pri hitrosti naleta $v = 10,3 \text{ km/h}$
 Fig. 13. The recorded characteristic for initial velocity $v=10,3 \text{ km/h}$

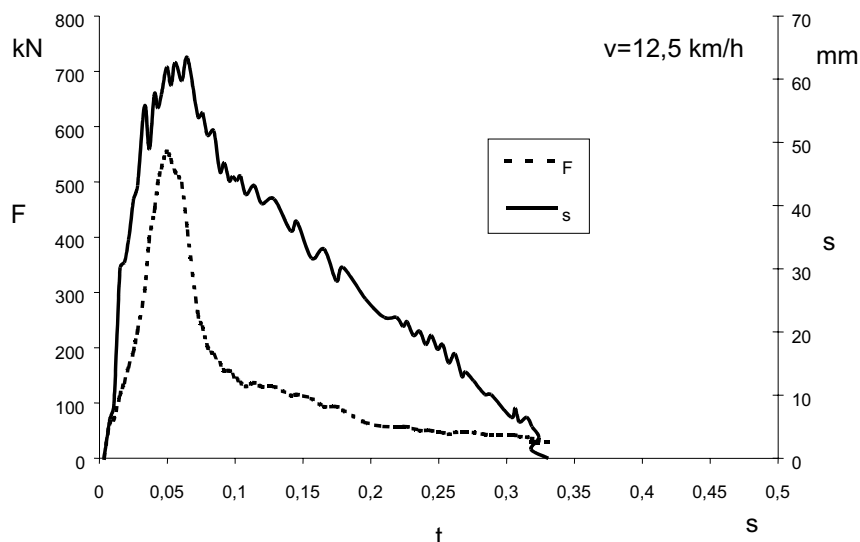

Sl. 14. Posneta karakteristika pri hitrosti naleta $v = 12,5$ km/h
 Fig. 14. The recorded characteristic for initial velocity $v=12,5$ km/h

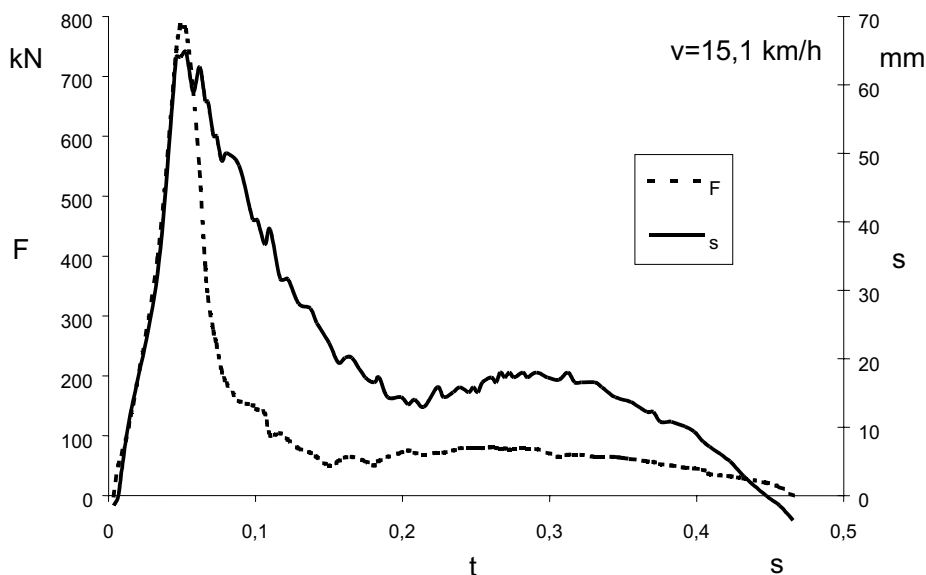

Sl. 15. Posneta potek sile in pomika v odvisnosti od časa pri hitrosti naleta $v = 15,1$ km/h
 Fig. 15. The recorded force and displacement depending on time at initial velocity $v=15,1$ km/h

je prikazano na sliki 16. Omenjena značilnost ima za posledico, da se pospešek z večanjem hitrosti naleta tudi zvišuje.

Ker sta zajeta signala sile in pomika podana v istem času t , je iz posnetih karakteristik opazno, da je največja vrednost sile vedno dosežena nekaj časa pred največjim pomikom odbojnika. To je posledica velikih deformacij elastomera, pri katerih mrežne vezi postanejo šibke.

Prav tako je ena od glavnih značilnosti posnetih karakteristik tudi dejstvo, da so krivulje, ki kažejo potek sile v odvisnosti od časa, bolj gladke od krivulj, ki prikazujejo časovni potek pomika. Narebričenost krivulj pomikov je posledica vibracij, ki jih merilnik pomika zaznamuje. Vibracije se med trkom prenašajo prek ogrodja vozila na drugi odbojnik in nasprotno.

increases, as shown in Fig. 16. The consequence of this fact is that acceleration increases with increasing initial velocity.

As the recorded force and displacement signals are given in the same time t , we can see from the characteristics that the highest force value is always reached slightly sooner than the highest displacement of the buffer. This is a consequence of high strains in the elastomer which weaken the crosslinking bonds.

Another typical feature of the recorded characteristics is the fact that the curves showing the force depending on time are smoother than the curves showing the displacements depending on time. The chattering of displacement curves is ascribed to the vibrations recorded by the gauge. During the collision, vibrations travel over the framework of the rail vehicle to the buffers of the next vehicle, and vice versa.

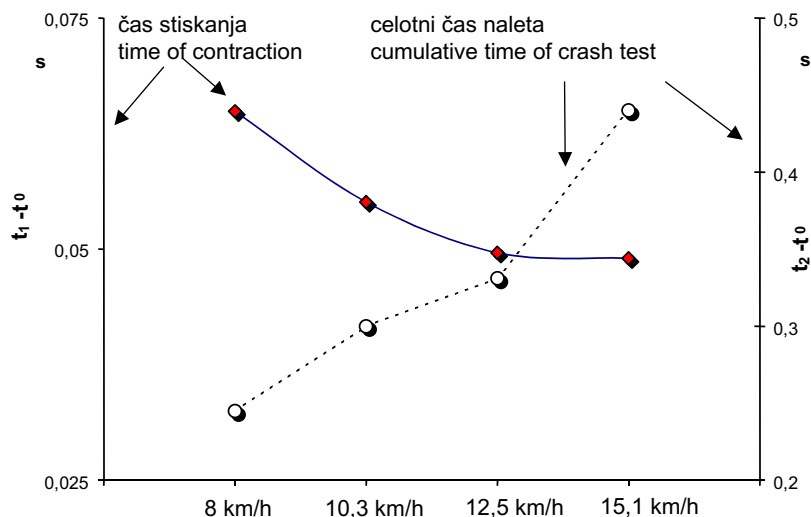

Sl. 16. Čas trajanja stiskanja ($t_1 - t_0$) in celotnega trka ($t_2 - t_0$) pri različnih hitrostih naleta
 Fig. 16. The duration of contraction ($t_1 - t_0$) for different initial velocities

Za določitev celotnega dela odbojnika med trkom, je treba izmerjene karakteristike vzmetnega paketa prikazati kot potek sile F v odvisnosti od pomika s . Odvisnost sila - pomik je za vsako hitrost posebej prikazana na slikah 17 do 20.

Nihanja pomika med trkom imajo za posledico izrazita osciliranja krivulje dinamičnega obremenjevanja v vodoravni smeri, zaradi česar lahko določevanje dela kot integrala pod krivuljo $F-s$ povzroči napako.

Zaradi tega je bila posneta krivulja za pomik poenostavljena. Vrednosti za celotno delo so izračunane z integracijo približne krivulje in so podane v preglednici 1.

Iz vrednosti povratnega dela vzmetnega paketa sta določena relativna hitrost vozil po trku

In order to determine the cumulative work of the buffer during the collision, the measured characteristics of the spring package have to be expressed by the force F as function of the displacement s . The force/displacement relationship for individual velocities is shown in Figs. 17 to 20.

Displacement variations occurring during the collision result in distinctive oscillations of the dynamic loading curve in the horizontal direction, which is the reason why the determination of work as an integral under the $F-s$ curve may result in an error.

Consequently, the recorded displacement curve was approximated. The values for cumulative work were calculated by the integration of the approximated curve (Table 1).

The value of the restitution work of the spring package was used to calculate the relative velocity of

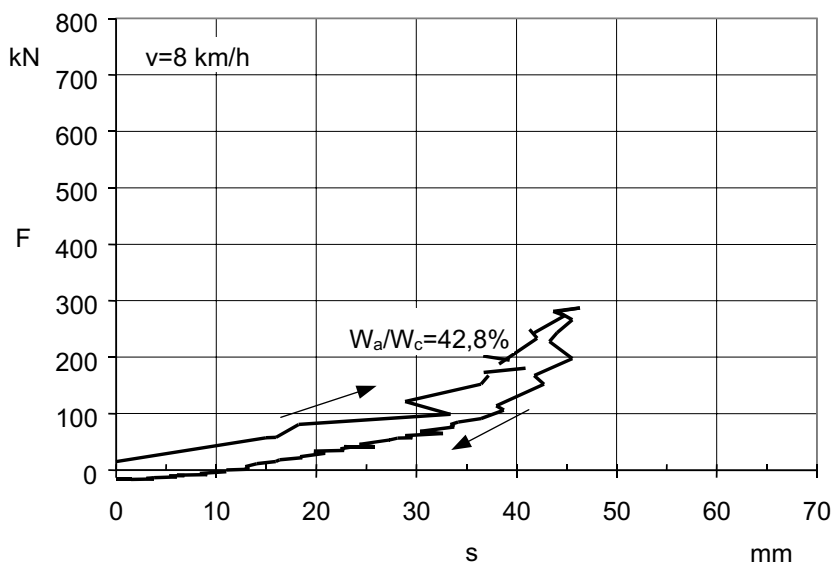

Sl. 17. Karakteristika sila - pomik ($F-s$) pri hitrosti naleta $v = 8$ km/h
 Fig. 17. Force/displacement ($F-s$) characteristic at initial velocity $v=8$ km/h

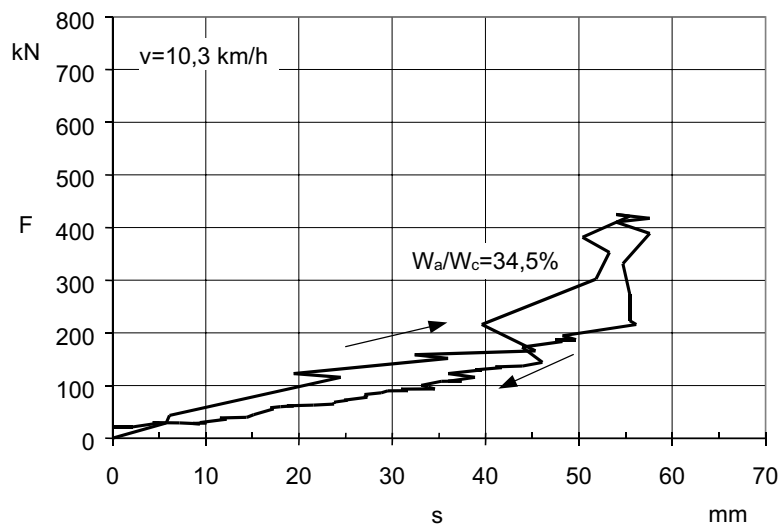

Sl. 18. Karakteristika sila - pomik ($F-s$) pri hitrosti naleta $v = 10,3 \text{ km/h}$
 Fig. 18. Force/displacement ($F-s$) characteristic at initial velocity $v = 10,3 \text{ km/h}$

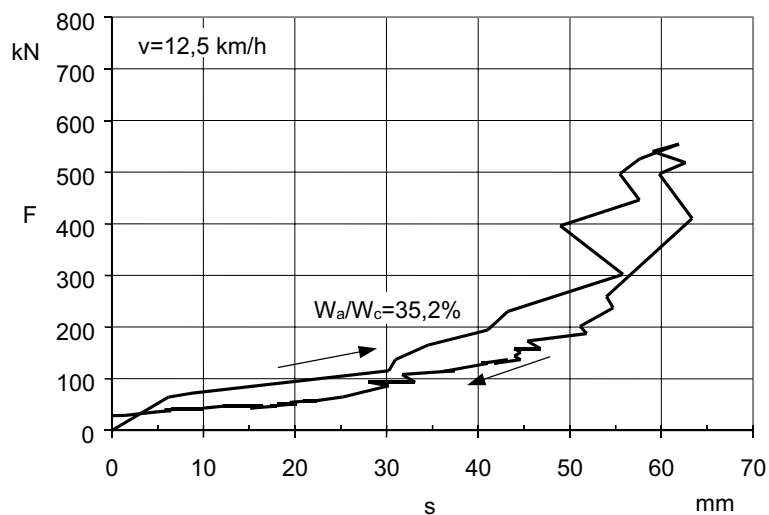

Sl. 19. Karakteristika sila - pomik ($F-s$) pri hitrosti naleta $v = 12,5 \text{ km/h}$
 Fig. 19. Force/displacement ($F-s$) characteristic at initial velocity $v = 12,5 \text{ km/h}$

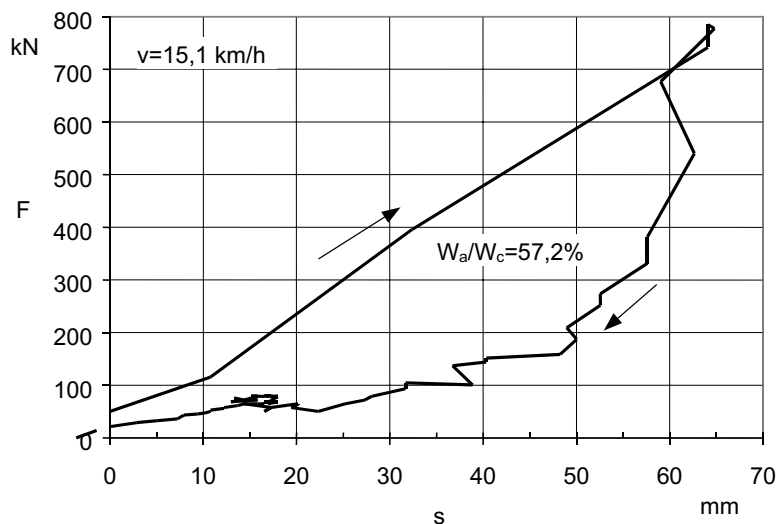

Sl. 20. Karakteristika sila - pomik ($F-s$) pri hitrosti naleta $v = 15,1 \text{ km/h}$
 Fig. 20. Force/displacement ($F-s$) characteristic at initial velocity $v = 15,1 \text{ km/h}$

$u_2 - u_1$ in koeficient trka k po enačbi (18). Izračunane vrednosti za povprečen pospešek mirujočega vozila in koeficienta trka s preostalimi značilnostmi razvitega vzmetnega paketa so podane v preglednici 1.

vehicles after collision $u_2 - u_1$ and the collision coefficient k following equation (18). The calculated values for the average acceleration of a vehicle at standstill (at rest) and the collision coefficient with the remaining characteristics of the developed spring package are given in Table 1.

Preglednica 1. Izmerjene značilnosti razvitega vzmetnega paketa med naletnim prekusom
Table 1. Measured characteristics of the developed spring package during collision test

V_1		$t_2 - t_0$	F_{maks}	a/g	W_c	W_a	W_a / W_c	$u_2 - u_1$	K
km/h	m/s	s	kN		kJ	kJ	%	m/s	
8	2,22	0,25	281	1,4	5,0	2,1	42,8	0,535	0,241
10,3	2,86	0,30	421	2,1	9,4	3,2	34,5	0,785	0,274
12,5	3,47	0,33	554	2,8	11,8	4,2	35,2	0,875	0,252
15,1	4,19	0,44	784	4,0	25,0	14,1	56,2	1,047	0,249

3 SKLEP

Z uporabo cenene standardnega vzorca iz elastomera je mogoče definirati reološke parametre, potrebne za izračun deformacijskega dela in s tem v grobem oceniti primernost elastomera za izdelavo prototipa oz. za vgradnjo v odbojno napravo. Odstopanja med deformacijskim delom, izračunanim po modelu, in eksperimentalno izmerjenim delom so predvsem posledica razlike v vezavi površine elastomera med standardnim vzorcem in realnim vzmetnim elementom. Zaradi tega je treba, da so pogoji preskušanja standardnega vzorca, kolikor se le da podobni pogojem obremenjevanja in vezave na dejanskem vzmetnem elementu. Razvit vzmetni paket izpolnjuje pogoje v skladu s standardi UIC glede poteka statične obremenitvene karakteristike (sila - pot) ter velikosti celotnega in dušenega dela. Prav tako vzmetni paket izpolnjuje pogoje za dinamična naletna preskušanja po standardih UIC.

Opravljeni naletni preskusi so pokazali, da je koeficient trka mogoče določiti le na podlagi neposrednih meritev na samem odbojniku, ker dejanski trk dveh natovorjenih železniških vozil spremljajo težje določljivi dinamični in geometrijski parametri. Iz primerjave časa dolžine stiskanja in raztezanja je mogoče sklepati, da odbojnik opravlja svojo vlogo blažilnika tako, da hitro akumulira energijo naleta ter nato počasi vrača del energije v obliki povratnega dela. Na temelju raziskave smo opazili, da razviti vzmetni paket nima vloge le vsrkati del energije naleta, temveč tudi preostali del energije povrniti v daljšem času, kar pa je doseženo z lastnostmi elastomera.

Opravljen raziskava je pokazala, da je mogoče na temelju kombiniranja eksperimentalnih meritev in reološkega modela številsko oceniti primernost elastomera za vgradnjo v zelo obremenjene - naletne konstrukcijske sklope in s tem uspešno nadomestiti kovinske vzmetno-dušilne elemente z elastomerom.

3 CONCLUSION

It is possible to define the rheological properties needed to calculate the deformation work by the use of a standard inexpensive elastomer specimen, and thus to evaluate the suitability of the elastomer for the development of a prototype spring package installed in a buffer. The deviation of the by-the-model calculated deformation work from the experimentally measured work is mainly a consequence of the difference in the binding of the elastomer surface in the case of the standard specimen and in the real spring element. For this reason it is imperative that the testing conditions of the standard specimen be as similar as possible to the loading and binding conditions of the real spring element. The developed spring package satisfies the requirements of the UIC standards regarding the static loading characteristic (force-path) and the magnitude of the cumulative and damping work. It also complies with the UIC dynamic crash testing standards.

The performed crash tests have shown that it is possible to determine the collision coefficient only by direct measurements on the buffer, which is explained by the fact that a real collision of two loaded vehicles is accompanied by dynamic and geometric parameters that are harder to determine. A comparison of the duration of contraction and restitution reveals that the buffer accumulates the crash energy quickly and then slowly returns a part of the energy in the form of restitution work. It is evident from the performed research that the developed spring package not only absorbs a part of the collision energy, but also recovers the non-absorbed part of the energy over a longer period of time, which is a consequence of the properties of the elastomer.

The performed research has also shown that by combining experimental measurements and the rheological model it is possible to quantitatively evaluate the suitability of the elastomer for installation into highly loaded crash-subjected parts, and to efficiently replace metal springs with elastomer elements.

ZAHVALA

Pričujoči prispevek prikazuje le del dejavnosti, ki so potekale pri raziskovalnem projektu "Razvoj, izdelava prototipa in preskušanje odbojnika za železniška vozila" (42-0909-795), v okviru raziskovalnega projekta Ministrstva za znanost in tehnologijo, ki so ga sofinancirale Slovenske železnice, RTI Sava Kranj in Tovarna vzmeti Ptuj. Avtorji se prav tako iskreno zahvaljujejo sodelavcem pri projektu mag. Andreju Jereletu in spec. Janezu Pičerku za njun prispevek k uspešnem delu pri omenjeni nalogi, kakor tudi RTI Sava Kranj pri dejavni vključitvi v razvoj, pripravo in izdelavo elastomera.

ACKNOWLEDGEMENT

The presented paper describes only a part of the research work performed within the research project "Development and Testing of Prototype Buffers for Railway Vehicles" (No. 42-0909-795). The authors wish to thank the Ministry of Science and Technology of Slovenia, the Slovenian Railway Company, R&D Sava in Kranj and Tovarna vzmeti in Ptuj for their financial support. The authors also wish to thank Mr. Andrej Jerele and Mr. Janez Pičerk for their successful cooperation on the project, and to the R&D Sava company in Kranj for their activities in the development and preparation of the elastomer.

4 LITERATURA

4 REFERENCES

- [1] UIC 526-1 (1981) Güterwagen – Puffer mit 100 mm Hub. *Internationaler Eisenbahnverband*.
- [2] UIC 827-2 (1981) Technische Lieferbedingungen für stählerne Pufferfederringe.
- [3] Beatty, M.F., D.O. Stalnaker (1986) The Poisson function of finite elasticity. *Jour. Applied Mechanics*, Vol. 53, 807-813.
- [4] Truesdell, C., W. Noll, The nonlinear field theories of mechanics. *Flügge's Handbuch der Physik*, Vol. III/3, 139-141, 153-158 and 317-319.
- [5] Blatz, P.J., W.L. Ko, Application of finite elasticity theory to the deformation of rubbery materials. *Transaction of the Society of Rheology*, Vol. 6, 223-251.
- [6] Legat, J., N. Gubelj, Č. Primec, J. Pičerk (1994) Razvoj, izdelava prototipa in preizkušanje odbojnika za železniška vozila 42-0909-795. Končno poročilo.
- [7] Jerele, A. (1994) Delovno poročilo o preizkusih v RTI Sava Kranj.
- [8] Gubanc, M., P. Murih, Z. Šusterič, A. Šebenik (1996) Vpliv mehčanja in zamreževanja naravnega kavčuka na dušenje vulkanizatov. *Sava Kranj, Razvojno tehnološki inštitut, Univerza v Ljubljani, FKKT*.
- [9] Jecić, S. (1989) *Mehanika II, Kinematika in dinamika, Školska knjiga Zagreb*.

Naslov avtorjev: prof.dr. Janko Legat
doc.dr. Nenad Gubelj
Jožef Predan
Fakulteta za strojništvo
Univerza v Mariboru
Smetanova 17
2000 Maribor

Authors' Address: Prof.Dr. Janko Legat
Doc.Dr. Nenad Gubelj
Jožef Predan
Faculty of Mechanical Engineering
University of Maribor
Smetanova 17
2000 Maribor, Slovenia

Prejeto: 5.8.1999
Received:

Sprejeto: 20.12.2000
Accepted: